

96513626 MAGNA 40-120 F 50 Hz

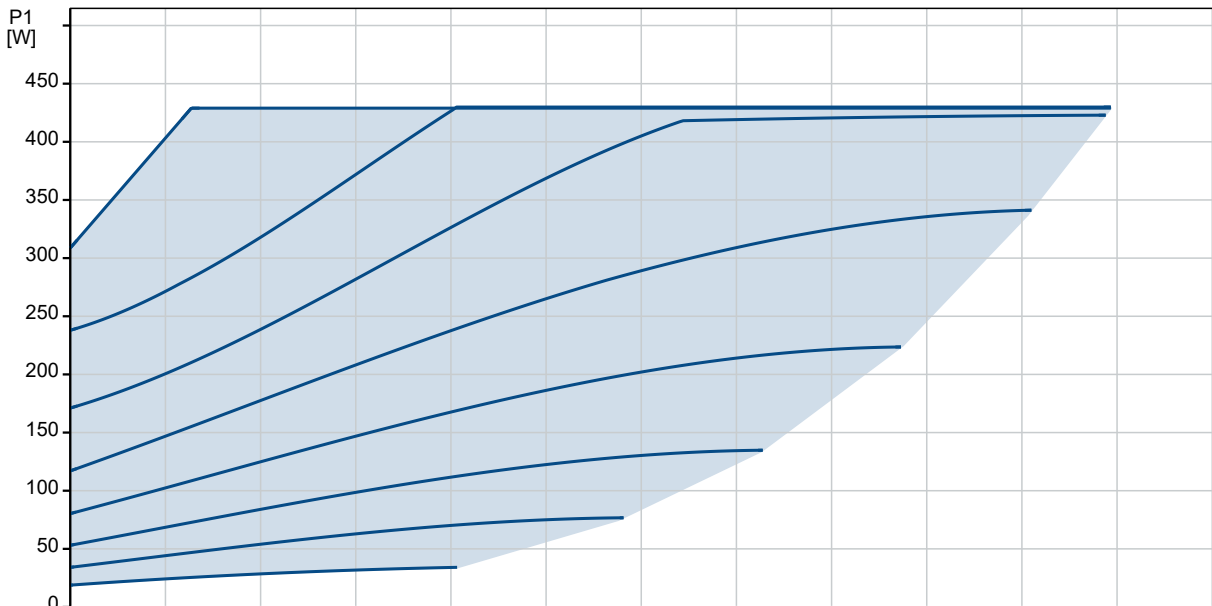

Description	Value
General information:	
Product name:	MAGNA 40-120 F
Product No:	96513626
EAN number:	5700396649870
Price:	
Technical:	
Head max:	120 dm
TF class:	110
Approvals:	CE, TSE, PCT
Model:	F
Materials:	
Pump housing:	Cast iron
Pump housing:	EN-JL1040
Pump housing:	ASTM 35 B - 40 B
Impeller:	Stainless steel
Impeller:	DIN W.-Nr. 1.4301
Impeller:	AISI 304
Installation:	
Range of ambient temperature:	0 .. 40 °C
Maximum operating pressure:	10 bar
Flange standard:	DIN
Pipe connection:	DN 40
Pressure rating:	PN 6 / PN 10
Port-to-port length:	250 mm
Liquid:	
Pumped liquid:	Water
Liquid temperature range:	2 .. 95 °C
Selected liquid temperature:	60 °C
Density:	983.2 kg/m ³
Electrical data:	
Power input - P1:	25 .. 450 W
Mains frequency:	50 Hz
Rated voltage:	1 x 230-240 V
Maximum current consumption:	0.17 .. 2 A
Enclosure class (IEC 34-5):	X4D
Insulation class (IEC 85):	H
Controls:	
Pos term box:	15
Others:	
Net weight:	15.5 kg
Gross weight:	17.5 kg
Shipping volume:	0.034 m ³
Norwegian NRF no.:	9043055

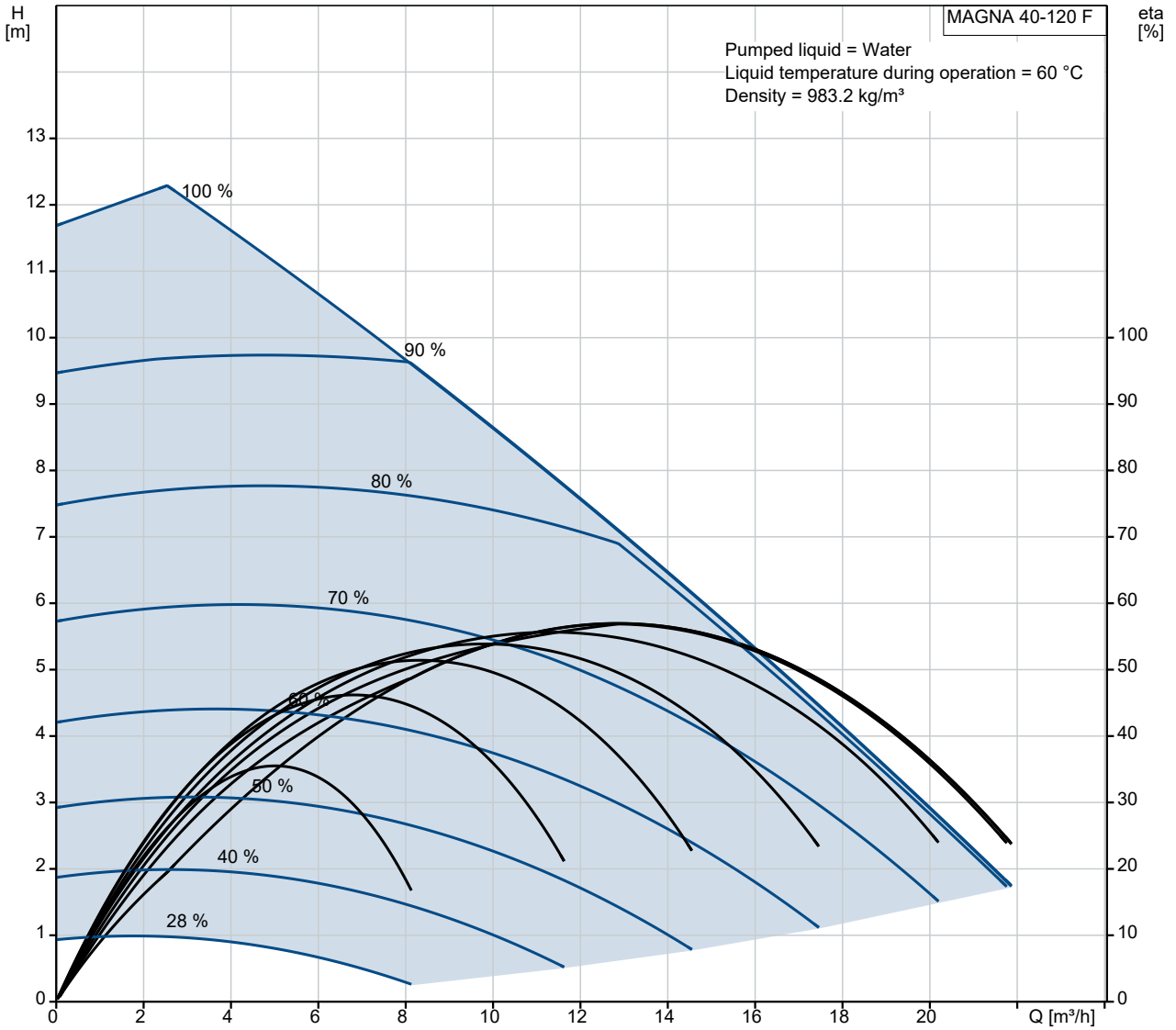
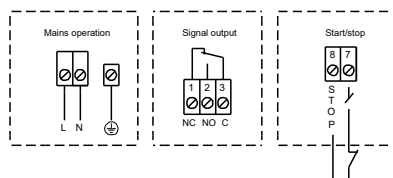
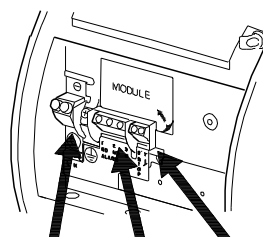
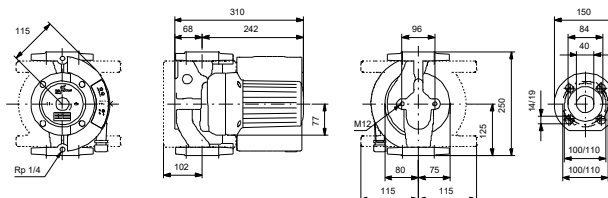
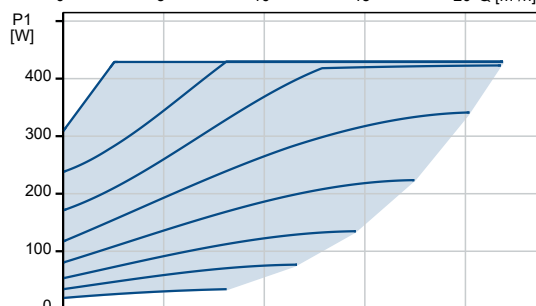
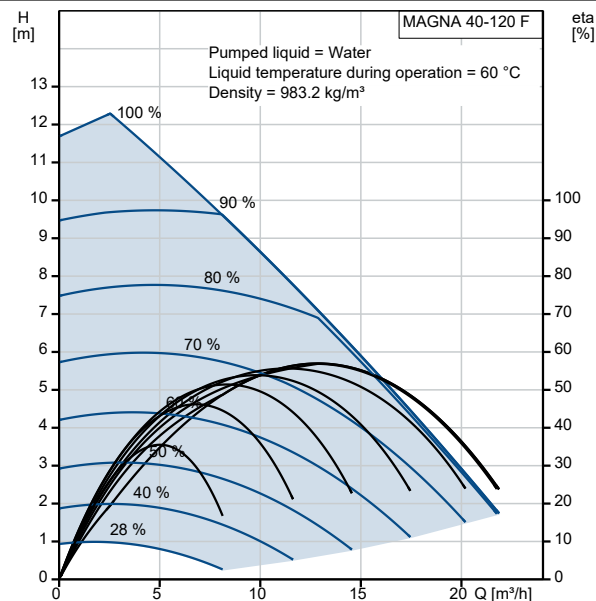

96513626 MAGNA 40-120 F 50 Hz

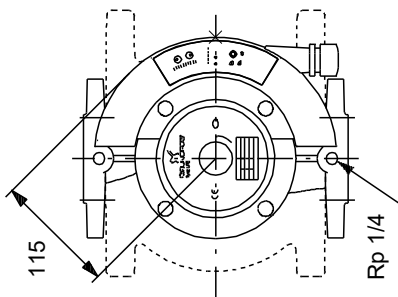
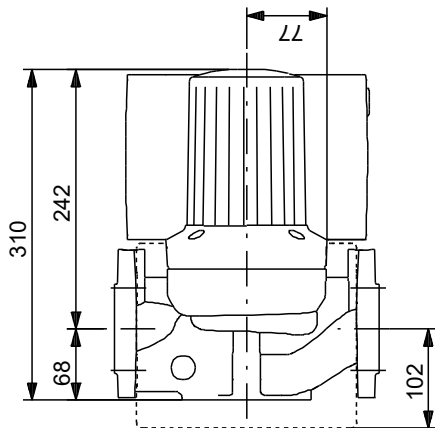
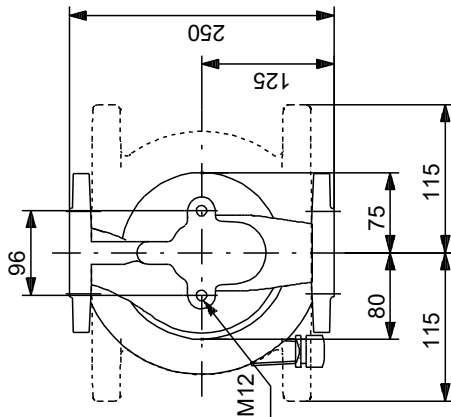
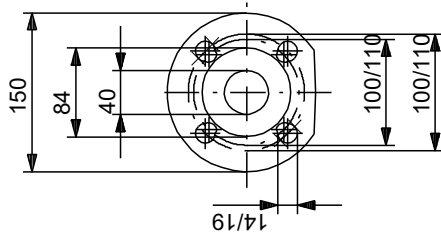

Note! All units are in [mm] unless others are stated.
Disclaimer: This simplified dimensional drawing does not show all details.